



Introducing the Hepco LoPro

Hepco LoPro has been introduced to provide the designer with a lightweight yet rugged linear slide system. LoPro is aluminium-based with steel tracks securely fixed, and is ideal for applications requiring medium accuracy guidance.

A range of track widths is available to closely match the requirements of a wide range of machine designs. As its name suggests, LoPro is compact and has a low overall profile making it suitable for space restricted applications where good load capacity is needed.

The unique Track Plate design incorporates a recess which can be used to accept the chosen means of driving. This brochure outlines the basic system, however LoPro will be developed in future to include a variety of drive options.

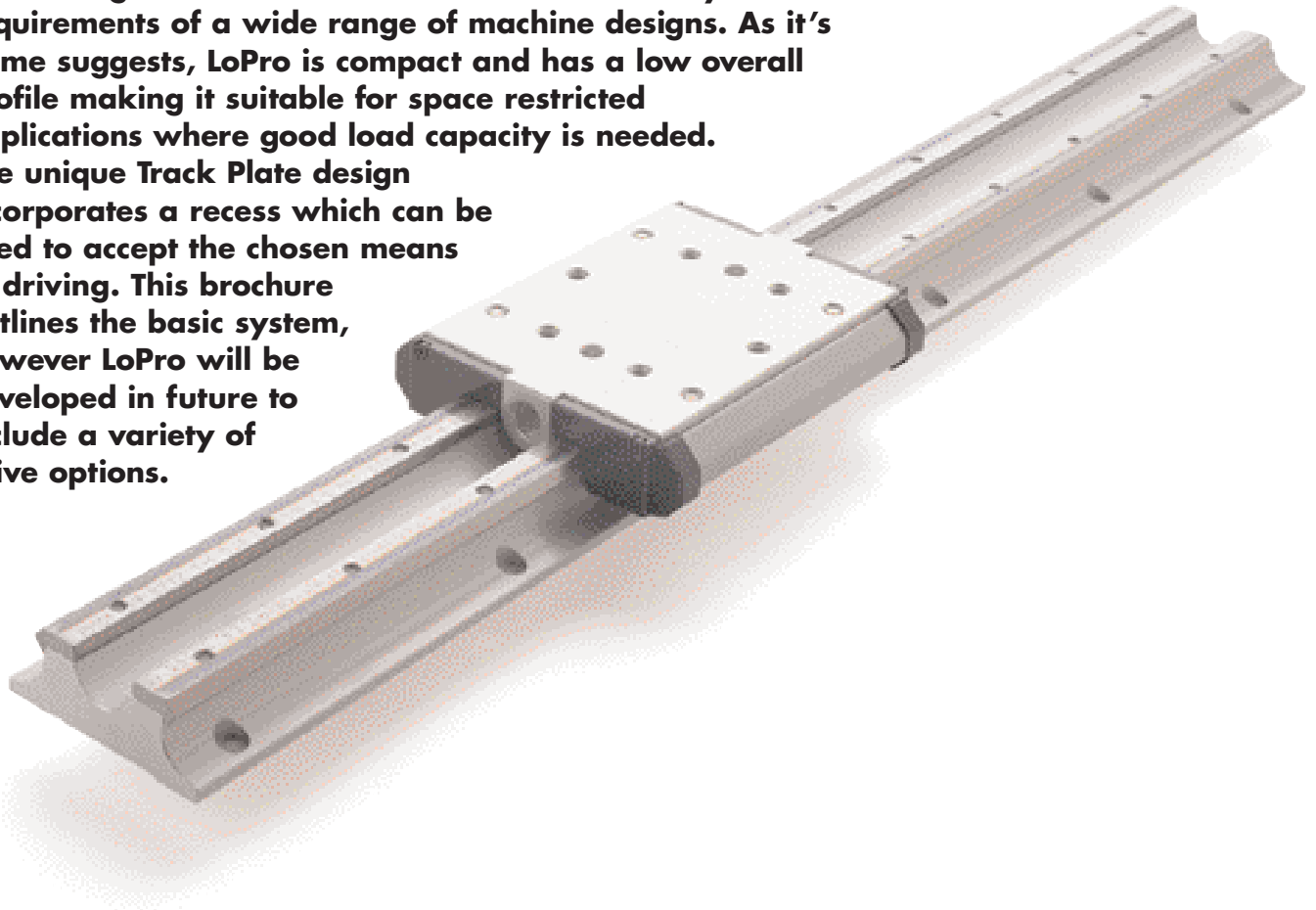

Features and Benefits

- Four different track widths to satisfy most designers' requirements
- Hardened 'vee' track contact surfaces with lubrication option, for long and trouble-free operation
- Aluminium base plate with steel track securely bolted - remains rigid and will not move under load
- Centre recess in base plate - enables various drive options to be considered
- Option of stainless steel track and guide wheels for a corrosion resistant system
- Double row angular contact bearing guide wheels for rugged performance
- Two different wheel plate options for maximum versatility
- Supplied as a complete assembly, ready for mounting
- Compact profile with wide, easy to use wheel plates

System Composition/Design Points

Hepco LoPro consists of an aluminium base plate with hardened 'vee' track, comprising the **Track Plate Assembly**, and an aluminium carriage plate with four guide wheels comprising the **Wheel Plate Assembly**.



The **Track Plate Assembly** is exceptionally rigid - the 'vee' track is securely fixed to the aluminium base plate by a number of bolts screwed into tapped holes along the track length. This method of fixing ensures that the track does not move on its base when heavy loads are applied.

The standard track is carbon steel, with stainless steel track and stainless steel wheels available as an option for those applications requiring a level of corrosion resistance. A recess between the tracks provides space for simple and compact routing of the drive.



The **Wheel Plate Assembly** is available in two options, Wiper and Basic. Both types are based around an aluminium extruded carriage plate, machined on the mounting surface, and provided with drilled and tapped component mounting holes and location dowel holes.



The **Wiper version** has four replaceable oiled felt wiper assemblies, which make contact with the 'vee' track to ensure constant lubrication. The result is significantly extended life, plus higher load carrying capacity. Wheels are enclosed by the wipers and side shields, giving excellent protection against the ingress of dirt and debris.

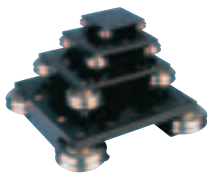

The **Basic version** is of a cheaper construction for the lower cost application where lubrication of the vee track is not necessary.

The availability of two types allows the designer to choose the most appropriate option based on cost and lubrication requirements.

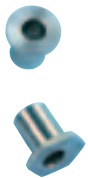

All wheel plate assemblies incorporate sealed double row angular contact bearings. Two eccentric bushes on one side of the wheel plate allow adjustment to eliminate free play, whilst concentric bushes on the other side are fixed to provide a reference point. All bushes are of stainless steel construction.



Systems are supplied by Hepco fully assembled and factory set. Under normal circumstances there should be no necessity for further adjustment by the customer. However, adjusting wrenches are available to enable disassembly and compensation for wear should this eventually occur.

Hepco LoPro is simple to install. The **Track Plate Assembly** has counterbored fixing holes in the base for mounting to a firm structure.

System Dimensions

Assembled System

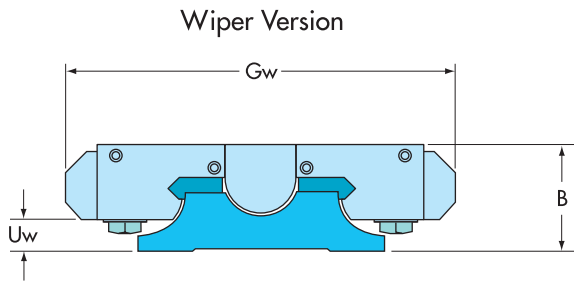

Size	1	2	3	4
A	50	72	102	140
B	23	33	43	55
B ₁	28	39	51	61
G _s	80	116	165	222
G _w	78.2	115.3	162.1	213.1
U	9.6	13.5	17.1	21.5
U _w	6.7	10.1	12.6	15.8

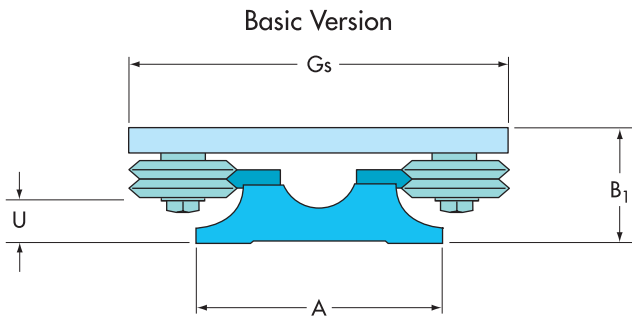

Wheel Plate Assembly

Size	1	2	3	4
D _p	4.4 x 2	7.4 x 4.3	8.3 x 4	10.9 x 4
D _s	90	127	172	242
D _w	86.4	122.3	166.6	231.7
E	64.5	96.5	132.1	172.7
F _w	94	129.9	177.6	243.8
J	-	30	38	66
J ₁	-	25	35	56
K	25	38	50	66
M	3/16"	1/4"	5/16"	5/16"
N	M4 x 0.7	M6 x 1.0	M8 x 1.25	M10 x 1.5
N _s	6	8	8	8
N _w	6	8	8	8
P	14	24	32	52
R	6	10	10	12
S	10	18	18	22
T	2.3	4.1	4.5	6.5
W	53.3	80	109.2	146.7
X	50	76	100	152
X ₁	50.8	76.2	101.6	152.4
Y	50	76	100	152

Wiper Version

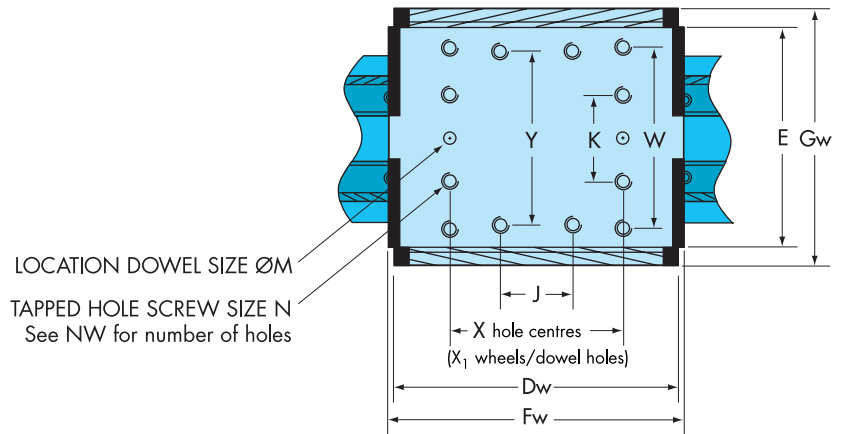

Basic Version

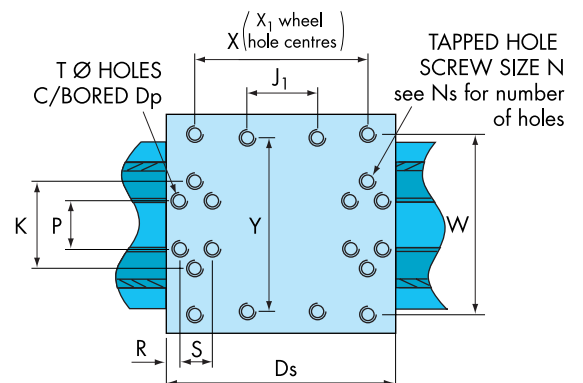

Location dowel holes M are drilled to accept imperial dowels

System Dimensions

Track Plate Assembly

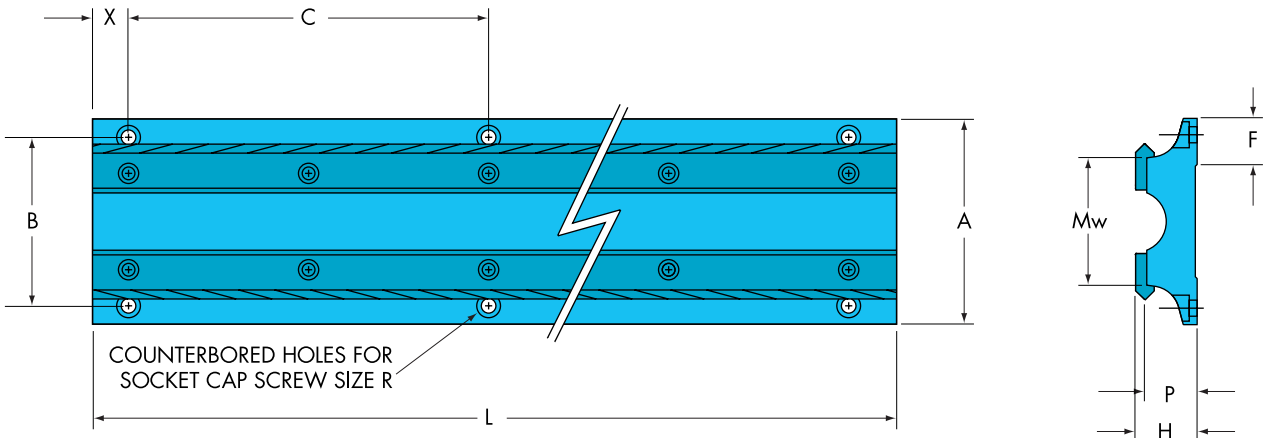

Size	1	2	3	4
A	50	72	102	140
B	40	59	81	111
C	76	126	152	178
F	10.5	15.8	25	46.5
H	15.9	22.2	29.4	36.6
Mw	31.1	45.1	58.4	80
P	13.5	19	25	31
X	30	30	30	30
R	M3	M5	M6	M8

1. Tolerances on all dimensions in the above tables (except X) will be ± 0.1 mm. Overall length tolerance L will be controlled to within ± 0.5 mm. Track parallelism is ± 0.04 mm over a 3 metre length.

2. Length L should be specified as multiples of $C + (2X)$. Non standard lengths can be supplied to customer's requirements. In these cases please contact Hepco's Technical Department for positioning of base and track holes. Maximum lengths in one piece:

Size 1 - 3024 mm

Size 2 - 3084

Size 3 - 3100

Size 4 - 3086

Example: Size 3 Track plate

$$\begin{aligned} \text{Total standard length } 1428\text{mm} &= 9 \times C + 2X \\ &= 9 \times 152 + 2(30) \end{aligned}$$

For joined systems (longer than above) track and base lengths will be staggered and supplied as matched and numbered sets, allowing unlimited lengths to be achieved. Hole spacing at the base plate join will be $2X$. Contact Hepco's Technical Department for application advice.

Technical Data

The load and life for Hepco LoPro systems will be determined by several factors including system size, the number and arrangement of wheel plates, the type and direction of the applied loads, speed of travel, length of stroke and the state of lubrication.

System size	Wheel Plate	Max. Direct Load*		Max. Moment Load*		
		L1	L2	M	Ms	Mv
1	wiper	660N	1320N	16.5Nm	12.5Nm	33Nm
1	basic	225N	225N	6Nm	3.8Nm	6Nm
2	wiper	1400N	2800N	53Nm	38Nm	106Nm
2	basic	450N	450N	16.5Nm	12Nm	16.5Nm
3	wiper	2100N	4200N	107Nm	75Nm	214Nm
3	basic	675N	675N	33Nm	24Nm	33Nm
4	wiper	3100N	6200N	240Nm	150Nm	480Nm
4	basic	975N	975N	75Nm	48Nm	75Nm

* Load figures should be reduced by 25% where the Stainless Steel option is specified.

Figures for wiper wheel plates are based on the basic dynamic load rating of the bearings. The figures for basic wheel plates assume unlubricated operation. If adequate alternative means of lubrication is provided, then the higher load figures for the wiper type wheel plates will apply.

How to Calculate the Expected Life of a System

The life of a system will be dictated by that component which fails first. In systems which are properly lubricated, the internal part of the wheels will determine the life. In unlubricated applications, the wear on the track and the outside of the bearings will be the life determining factor.

In all systems, the forces on the wheel plate of a system can be resolved into a combination of 5 direct and moment loading modes as follows:

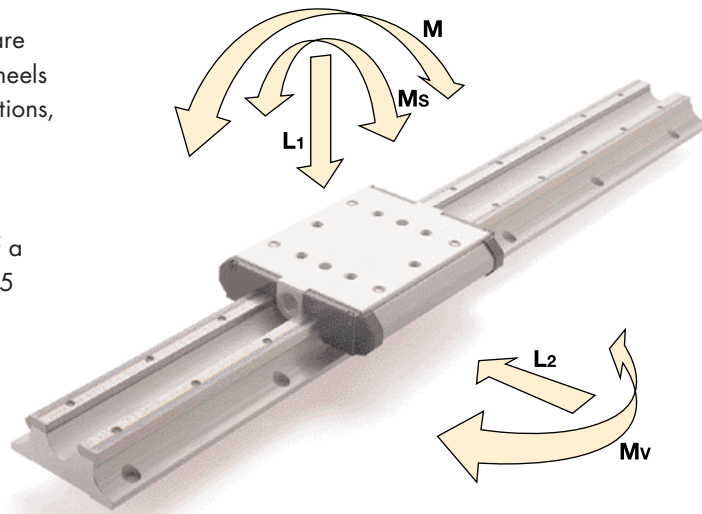

Once the system load has been resolved into the (up to) 5 components of direct and moment load, then the **Load factor** LF can be calculated using the following formula:

$$L_F = \frac{L_1}{L_{1_{\max}}} + \frac{L_2}{L_{2_{\max}}} + \frac{M}{M_{\max}} + \frac{M_s}{M_{s_{\max}}} + \frac{M_v}{M_{v_{\max}}}$$

It should be noted that under no circumstances should the load factor exceed a value of 1. Load factors in excess of 0.7 for lubricated duties may take the bearings beyond their static load capacity, which could impair running quality.

Once this load factor has been calculated, the resultant figure should be inserted into the appropriate life formula below, to calculate the system life in km:

$$\text{For size 1 systems: LIFE (km)} = \frac{280}{(\text{LF})^3}$$

$$\text{For size 2 systems: LIFE (km)} = \frac{450}{(\text{LF})^3}$$

$$\text{For size 3 systems: LIFE (km)} = \frac{670}{(\text{LF})^3}$$

$$\text{For size 4 systems: LIFE (km)} = \frac{890}{(\text{LF})^3}$$

The life figures quoted above are based on the theoretical (L10) life for each wheel and assume that the system is running in a normal shock-free duty, that the stroke is longer than the wheel plate and that the system is adequately lubricated (for lubricated operation). Any adverse conditions will reduce the system life, so it is recommended to use a generous factor of safety where conditions are less than ideal, or where the reliability required is high.

Ordering Details

Simply specify the track plate size and length required together with the appropriate size and number of Wheel Plate assemblies per system. The Wheel Plate assembly will be factory set to the relevant track plate.

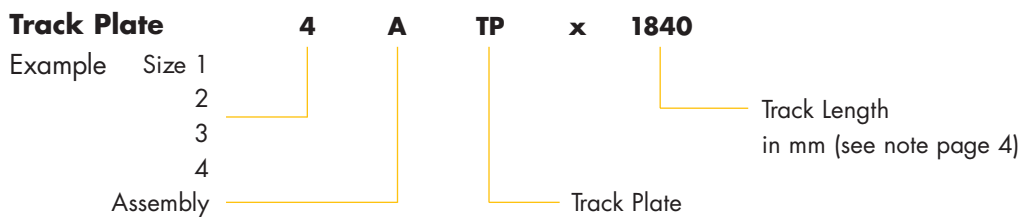

Maximum Track Plate length in one piece:	
Size 1	3024mm
Size 2	3084mm
Size 3	3100mm
Size 4	3086mm

Longer system lengths are available by butting to produce matched sets (see page 4 for details).

For Stainless Steel Track prefix size with **SS**

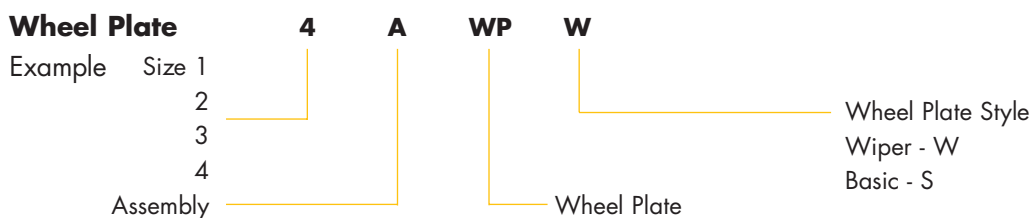

For Stainless Steel Guide Wheels prefix size with **SS**

Note: When ordering state the number of wheel plates per track length.

Adjusting Wrenches Order by stating the system size (1,2,3,4) followed by **PWRB** for the wheel bolts and **PWRX** for the eccentric bushes e.g. **4PWRB**. Both types of wrench are required for the adjustment procedure.



GV3



HDS

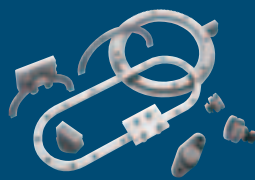

RTS

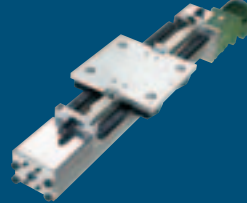

HDLS

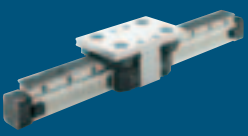

HPS

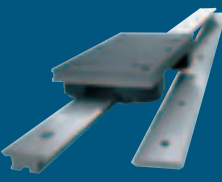

SL2

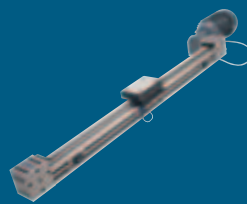

DLS

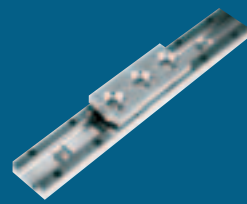

Utilitrak

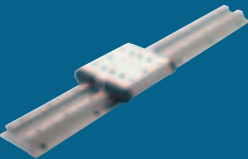

LoPro

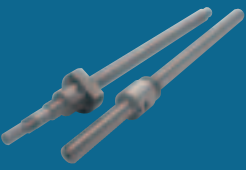

FB

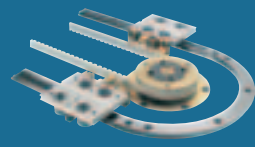

DTS

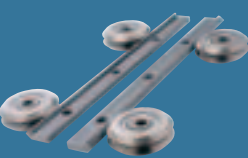

Dual-Vee



SH

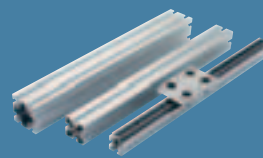

MCS

**Hepco products are available worldwide -
please request our catalogue FPL
or visit our website:
www.hepco.co.uk**



Guiding You Towards the Future

HEPCO SLIDE SYSTEMS LIMITED
Lower Moor Business Park, Tiverton Way
Tiverton, Devon, England EX16 6TG
Tel: 01884 257000
Fax: 01884 243500
hepco.sales@hepco.co.uk



CATALOGUE No. LoPro 03 UK © 2002 Hepco Slide Systems Ltd.

Reproduction in whole or part without prior authorisation from Hepco is prohibited. Although every effort has been made to ensure the accuracy of the information in this catalogue, Hepco cannot accept liability for any omissions or errors. Hepco reserves the right to make alterations to the product resulting from technical developments.

Many Hepco products are protected by: Patents, Copyright, Design Right or Registered Design. Infringement is strictly prohibited and may be challenged in law.

The Customer's attention is drawn to the following clause in Hepco's conditions of sale:

'It shall be the Customer's sole responsibility to ensure that goods supplied by Hepco will be suitable or fit for any particular application or purpose of the Customer, whether or not such application or purpose is known to Hepco. The Customer will be solely responsible for any errors in, or omissions from, any specifications or information the Customer provides. Hepco will not be obliged to verify whether any such specifications or information are correct or sufficient for any application or purpose.'

Hepco's full conditions of sale are available on request and will apply to all quotations and contracts for the supply of items detailed in this catalogue.

